

- 230Vac mono-phase control unit.
- For rolling shutters and awainings.
- 3 slowing down, self-learning of working time, 4 functions, integrated radio-receiver

START-S1XL v2

433.92 Mhz radio receiver included

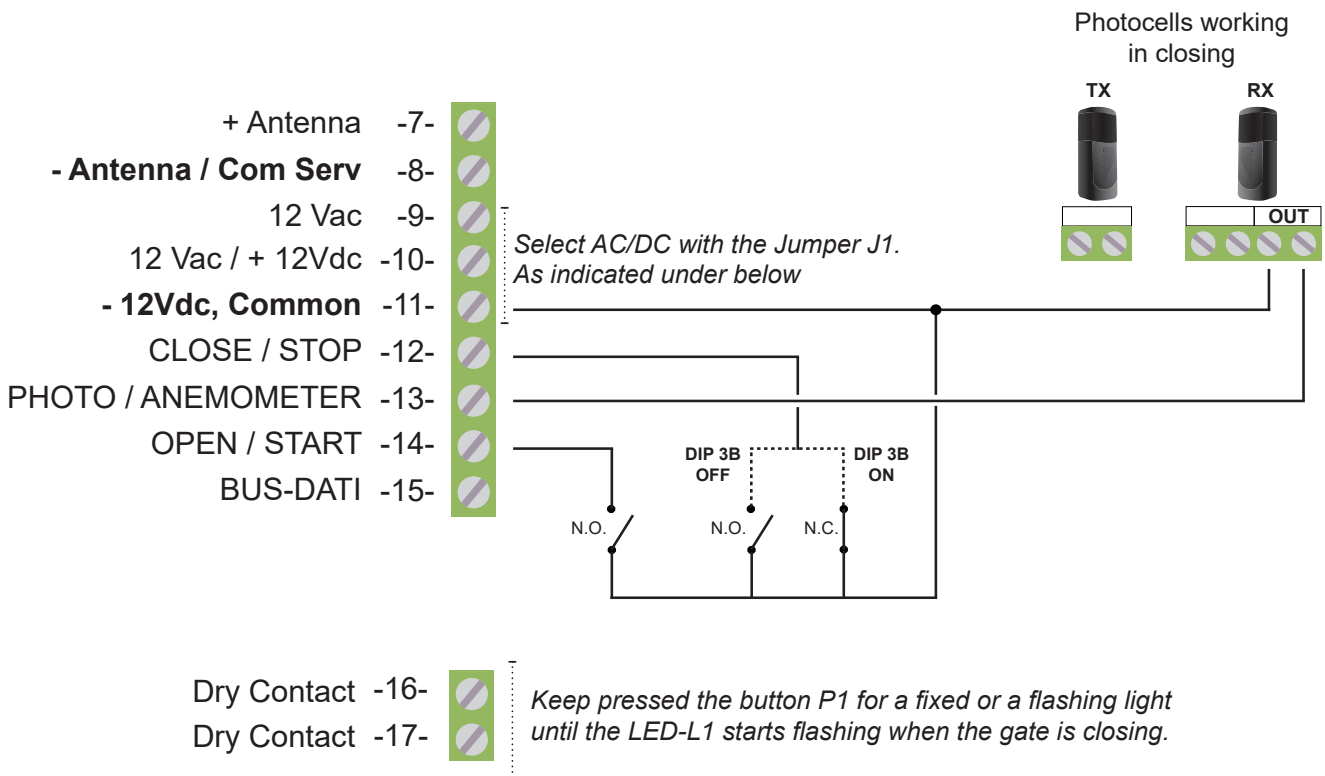
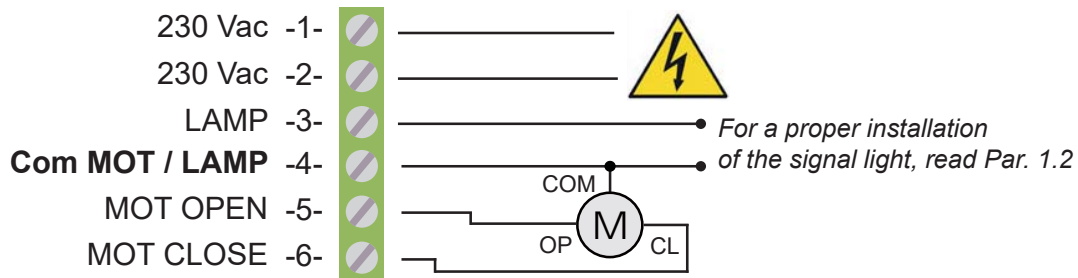

Power supply of the ACCESSORIES



JUMPER J1
AC - 12 Vac
Term. board 9-10



JUMPER J1
DC - 12 Vdc
Term. board 10-11



Foreword

This manual provides all the specific information you need to familiarize yourself with and correctly operate your unit. Read it very carefully when you purchase the instrument and consult it whenever you have doubts regarding use and before performing any maintenance operations. Nologo has the right to modify the product without previous notice.

Environmental protection measures

Information regarding the environment for customers within the European Union. European Directive EC 2002/96 requires that units bearing this symbol on the unit and/or on the packaging be disposed of separately from undifferentiated urban wastes.



The symbol indicates that the product must not be disposed of with the normal household wastes. The owner is responsible for disposing of this product and other electrical and electronic equipment through specific waste collection facilities indicated by the government or local public agencies. Correct disposal and recycling help prevent any potentially negative impact on the environment and human health. To receive more detailed information regarding disposal of your unit, we recommend that you contact the competent public agencies, the waste collection.

Symbols and warning

	<p><u>DANGEROUS</u></p> <p>This is a warning and if it is not respected it can provoke material damage.</p>
	<p><u>DEVICE UNDER TENSION</u></p> <p>The installation should be done only from professional installer.</p>
	<p><u>READ CAREFULLY THE OPERATING MANUAL</u></p> <p>Read carefully this manual before installation and keep it for the future.</p>

Safety precautions

Using the unit improperly and performing repairs or modifications personally will void the warranty. The producer declines any responsibility for damages due to inappropriate use of the product and due to any use other than the use the product was designed for. The producer declines any responsibility for consequential damages except civil liability for the products. Every programming and/or every maintenance service should be done by qualified technicians.

Introduction

START S1XL is a new generation control panel with digital working time. It has been designed with a high technology to guarantee against interferences, flexibility and a wide range of functions

Index

Cap		Pag
1	Installation	3
1.1	Diagram of the control unit	
1.2	Connection of the 230 Vac SIGNAL LIGHT	4
1.3	Power supply of the ACCESSORIES	
2	Functions	4
2.1	Modes of operation	5
2.2	STANDARD version: A / B "MAN DEATH'S FUNCTION" version	6
2.3	STANDARD version: C / D	7
2.4	"ANEMOMETER" Version: AN / AN-1	8
2.5	CENTRAL OPEN/CLOSE (ACC) version	9
	Remote control:	10
3	Cancellation of the memory	
3.1	Activation of the codes	
3.2	Code memorisation	11
4	Programming	12
4.1	Working time program	
4.2	Cancellation of the Working time	
4.3	Fixed light or flashing	
5	Connection of the BUS DATA SYSTEM	13
5.1	Example of the installation of BUS L2XL	
6	Note	14
7	Declaration of CE conformity	15

1 Installation

1.1 Diagram of the control unit

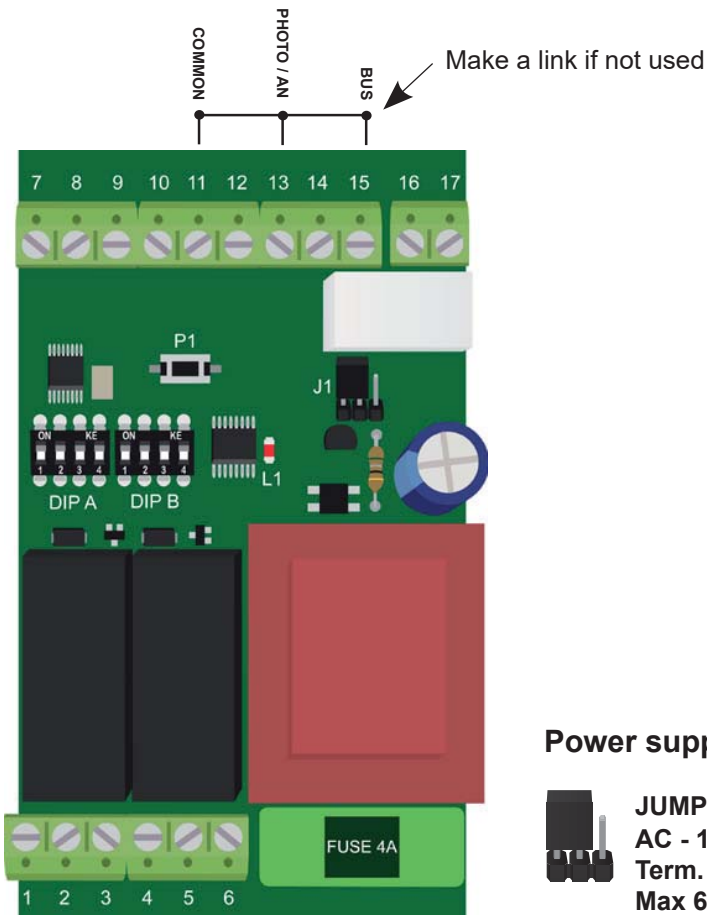

- ! The control unit has been designed for mechanical limit switches.
- ! If the control unit is installed in rolling shutters or awnings, DIP 3B and DIP 4B should be in OFF position.
- ! **PHOTO-BEAMS 11 - 13:** If the motor is not closing, it inverts the direction (NC input).
- ! **ANEMOMETER 11 - 13:** CLOSE and STOP the automation for 3 minutes (NC input)





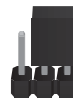

Power supply of the ACCESSORIES











JUMPER J1
AC - 12 Vac
Term. board 9-10
Max 60 mA



JUMPER J1
DC - 12 Vdc
Term. board 10-11
Max 60 mA

230 Vac	1		Electrical power supply 230 Vac 50 Hz
230 Vac	2		Electrical power supply 230 Vac 50 Hz
Signal Light	3		Output for 230 Vac signal light
Com MOT/LAMP	4		Output for connection of COMMON motor pole and 230 Vac signal light
MOT OPEN	5		Output for connection of OPENING motor pole
MOT CLOSE	6		Output for connection of CLOSING motor pole

+ Antenna	7		Input for antenna signal: +
Common	8		Common for all inputs: services, safety devices, coaxial cable.
12 Vac	9		Output 12 Vac (J1 - AC) Max 60 mA
12 Vac / +12 Vdc	10		Output 12 Vac (J1 - AC) / Output + 12 Vdc (J1 - DC) Max 60 mA
-12 Vdc / Com	11		- 12Vdc (J1 - DC), Common services and securities
CLOSE / STOP	12		Input command CLOSE or ALT up to DIP4-B
PHOTO / ANEM	13		Input for photo-beams / anemometer
OPEN / START	14		Input commande OPEN or STEP BY STEP up to DIP 3-B
BUS-DATI	15		Bus data // Make a link when not used

Dry contact	16		"Dry" contacts for light or flashing light without intermittance circuit board
	17		

1.2 Connection of the 230 Vac SIGNAL LIGHT

The signal light has to be without flashing electronic card, as the lashing is from the relay. So follow the the manual under below

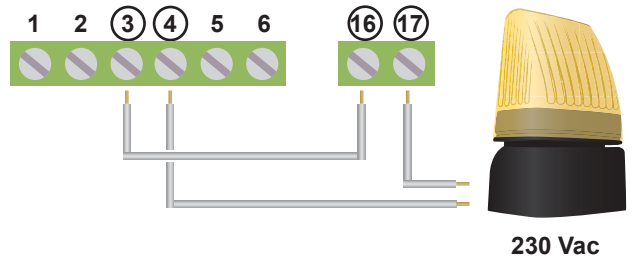

! If you use for a 24V light, this connection cannot be used.

1.3 Power supply of the ACCESSORIES



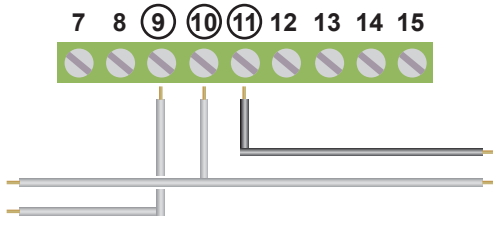

! Terminal board 9 / 11
Voltage: 12 Vac
MAX current: 60 mA
 Put **JUMPER JAC/DC** as shown in the picture



! Terminal board 10 (+) / 11 (-)
Voltage: 12 Vdc
Corrente MAX: 60 mA
 Put **JUMPER JAC/DC** as shown in the picture

2 FUNCTIONS

The control panel has 4 functions indicated on page.no5. We remind that the control panel is set up in STANDARD FUNCTION. If you need to change another function follow this steps:

1		Turn off the control unit, take out the 230V tension.
2	 230 Vac	Connect the control unit START-S1XL after a while again
3	 LED L1 fissa	The LED L1 remains lit. Within 5 seconds:
4	 P1	Press and release the button P1
5	 LED L1	Count the flashing of the LED L1 - 1 Flash: STANDARD FUNCTION ACTIVATED - 2 Flashes" Man Death's Function - 3 Flashes: with Anemometer - 4 Flashes: centrally open and close
6		LED L1 is lit on for 5 seconds, in this period you can go back to point no.4 and then press button P1 to choose a different function. <i>Otherwise go to the next step.</i>
7		Wait LED L1 turns normal flashes

2.1 Operation System

Here are listed all functions and we recommend to read carefully and choose with DIPB the right functions shown in the following pages

STANDARD version (*Default*)

- A** Command OPEN-STOP-OPEN with the 1st Button of the remote control.
OPEN-STOP-CLOSE with the 2nd button of the remote control,
no automatic reclosing.
- B** Like **B** but with automatic reclosing.
- C** Command STEP BY STEP (open-stop-close-stop) with remote control and button,
security button ALT, without automatic reclosing
- D** Same as **C** but with automatic reclosing.

“MAN DEATH’S FUNCTION” version

- UP** OPEN 1st command, 2nd command CLOSE via remote controls or via buttons.
The signal will be transmitted until the button won't be released

“ANEMOMETER“ version

- AN** STABLE CONTACT (open-stop-close-stop) with remote control and button,
ALT button for safety, without automatic reclosing.
- AN-1** AN-1 Command like OPEN-STOP-OPEN with 1st channel of the remote control and button,
CLOSE-STOP-CLOSE with 2nd channel of the remote control and button,
without automatic reclosing.

CENTRAL OPEN/CLOSE

- ACC** This mode of operation allows you to have a command of only OPEN (terminal 13) and one of only CLOSES (terminal 12). The command ends can become STOP command with DIP 3B set to ON, refer to p. 9. (In this mode you can not install the safety photocells).

Obviously the START command (terminal 14) follows the step-by-step logic.

2.2 STANDARD version: A / B - “MAN DEATH’S FUNCTION” version

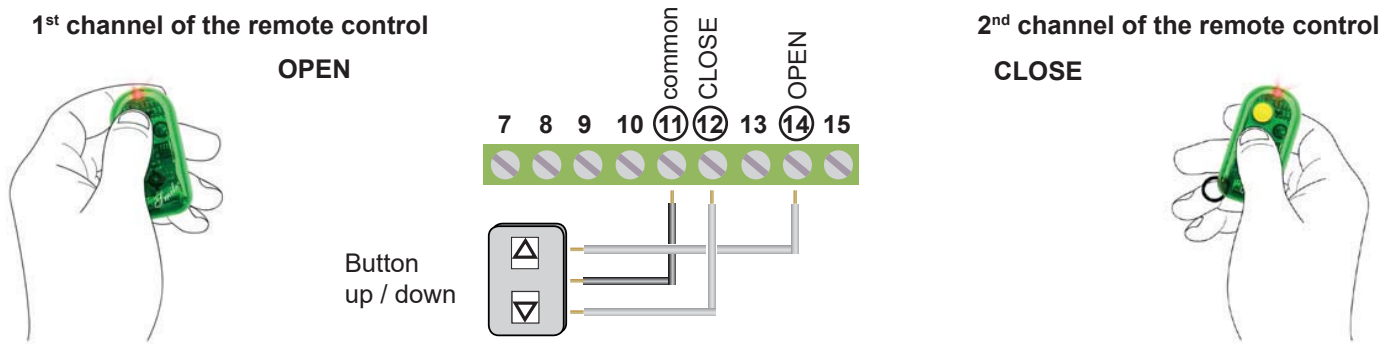

A program: no automatic reclosing



DIP 3-B OFF
DIP 4-B OFF

Remote control		
1° ch TX	OPEN-STOP-OPEN-STOP...	
2° ch TX	CLOSE-STOP-CLOSE-STOP...	

Terminal board		
11 - 14	same as 1st ch TX	
11 - 12	same as 2nd ch TX	
11 - 13	photo-cell inverts when closing	<i>make a link when not use</i>
11 - 15	bus-dati	<i>make a link when not use</i>

B program: with automatic closing after pause time



DIP 3-B OFF
DIP 4-B ON

Remote control		
1° ch TX	OPEN-STOP-OPEN-STOP...	
2° ch TX	CLOSE-STOP-CLOSE-STOP...	

Terminal board		
11 - 14	same as 1st ch TX	
11 - 12	same as 2nd ch TX	
11 - 13	photo-cell inverts when closing	<i>make a link when not use</i>
11 - 15	bus-dati	<i>make a link when not use</i>

UP program: “MAN DEATH’S FUNCTION” function

Remote control		The automatic reclosing is not available
1° ch TX	OPEN “MAN DEATH’S FUNCTION”	
2° ch TX	CLOSE “MAN DEATH’S FUNCTION”	

Terminal board		
11 - 14	same as 1st ch TX	
11 - 12	same as 2nd ch TX	
11 - 13	photo-cell inverts when closing	<i>make a link when not use</i>
11 - 15	bus-dati	<i>make a link when not use</i>

2.3 STANDARD version: C / D

1st channel of the remote control

START step by step

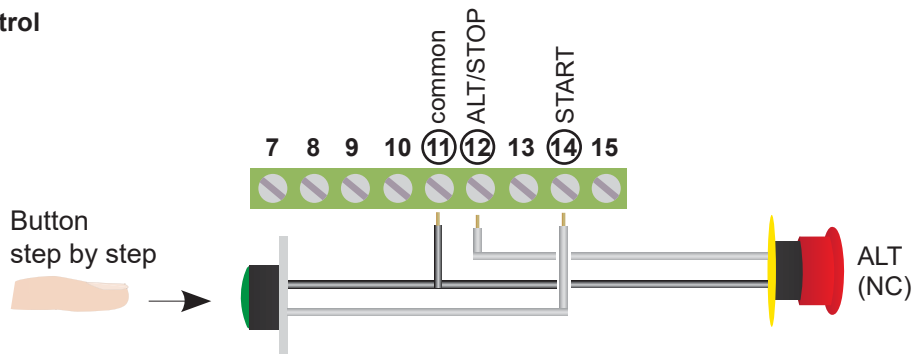

C program: no automatic reclosing



DIP A



DIP B

DIP 3-B ON
DIP 4-B OFF

Remote control

1° ch TX	OPEN-STOP-CLOSE-STOP...	
2° ch TX	CLOSE-STOP-CLOSE-STOP...	

Terminal board

11 - 14	same as 1st ch TX	
11 - 12	ALT button NC	<i>make a link when not use</i>
11 - 13	photo-cell inverts when closing	<i>make a link when not use</i>
11 - 15	bus-dati	<i>make a link when not use</i>

D program: with automatic closing after pause time



DIP A



DIP B

DIP 3-B ON
DIP 4-B ON

Remote control

1° ch TX	OPEN-STOP-CLOSE-STOP...	
2° ch TX	CLOSE-STOP-CLOSE-STOP...	

Terminal board

11 - 14	same as 1st ch TX	
11 - 12	ALT button NC	<i>make a link when not use</i>
11 - 13	photo-cell inverts when closing	<i>make a link when not use</i>
11 - 15	bus-dati	<i>make a link when not use</i>

2.4 “ANEMOMETER” Version: AN / AN-1

1 st channel of the remote control
START step by step

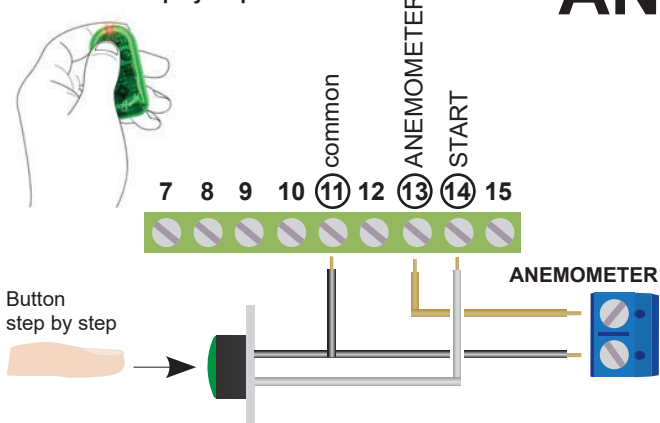

AN AN-1

2nd channel of the remote control
CLOSE

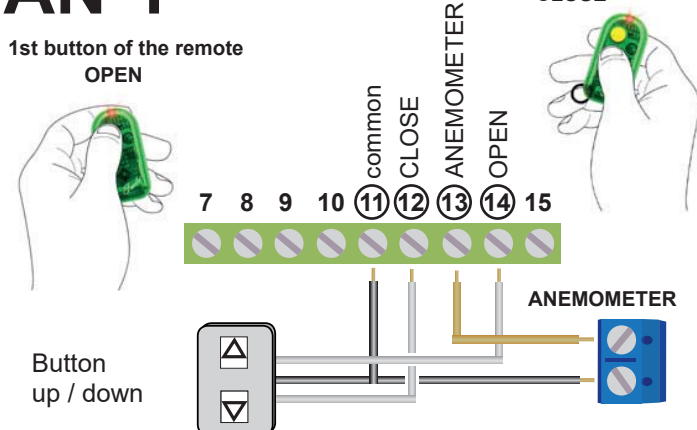

AN program:



Remote control		The automatic reclosing is not available
1° ch TX	OPEN-STOP-CLOSE-STOP...	
2° ch TX	CLOSE-STOP-CLOSE-STOP...	

DIP 3-B ON
DIP 4-B OFF
low wind speed
(more sensitive)

DIP 4-B ON
high wind speed
(low sensitive)

Terminal board		
11 - 14	same as 1st ch TX	
11 - 12	ALT button NC	<i>make a link if not used</i>
11 - 13	Anemometer it inverts and stop the control unit for 3 min	
11 - 15	bus-dati	<i>make a link if not used</i>

AN-1 program:



DIP 3-B OFF

DIP 4-B OFF
low wind speed
(more sensitive)

DIP 4-B ON
high wind speed
(low sensitive)

Remote control		The automatic reclosing is not available
1° tasto	OPEN-STOP-OPEN-STOP...	
2° tasto	CLOSE-STOP-CLOSE-STOP...	

Terminal board		
11 - 14	same as 1st ch TX	
11 - 12	same as 2nd ch TX	
11 - 13	Anemometer it inverts and stop the control unit for 3 min	
11 - 15	bus-dati	<i>make a link if not used</i>

! *It 'should be used, in combination with the central START-S1XL set mode AN or AN-1, an anemometer of the type "1 pulse per revolution"*

2.5 CENTRAL OPEN/CLOSE (ACC) version

ACC program:



DIP 3-B OFF
The CLOSE Command (terminal 12) only allows the closure, if pressed again does not STOP.

DIP 3-B ON
The entrance CLOSE (terminal 12) only works as a STOP input.

Remote control		
1° tasto	OPEN-STOP-CLOSE-STOP...	
2° tasto	CLOSE-STOP-CLOSE-STOP...	

Terminal board		
11 - 14	same as 1st ch TX	
11 - 12	Check setting DIP3B	
11 - 13	OPEN command only (does not STOP)	
11 - 15	bus-dati	<i>make a link if not used</i>

! *In this operating mode, you can't install the safety photocells.*

Example ACC mode

Now is a practical example for the installation of central START-S1XL vers.2, set in ACC mode (OPEN / CENTRAL LOCKING). This mode of operation permits to operate one or more control units via a single command, and then allows the opening or closing full automation by pressing a single tasto. The CLOSE input (terminal 12) only works as a STOP input.

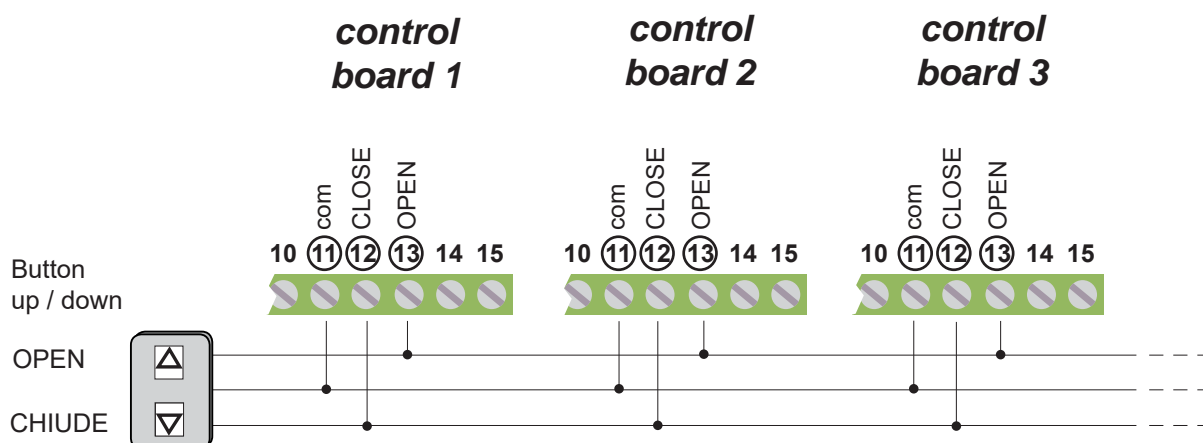

3 Remote control: Cancellation of the memory

The control unit has a **P1** button for different operation (cancellation of the codes,too). To cancel the codes make as follow:

The outputs should be deactivated, no contacts available, the lights should be turned off.

This operation can be done only when the gates is closed

1	Press and keep pressed the BUTTON P1 , LED L1 will lit on.
2	LED L1 will turn off after 6 seconds and you can release P1 . LED L1 will flash 4 times irregularly and then regularly and it is ready for the memorization of fixed codes. (1 regular flash see next chapter). <i>The memory has been cancelled.</i>

3.1 Remote control: *Activation of the codes*

The receiver of START-S1XL can manage fixed and rolling codes. The outputs should be deactivated!

The outputs should be deactivated, no contacts available, the lights should be turned off.

This operation can be done only when the gates is closed

1	Press and release BUTTON P1 , LED L1 will lit on for 6 seconds. Then:
2	Press and release (within 6 seconds) button P1 , LED L1 flash one time and then lit on for 6 seconds.
3	Press and release the button P1 again (in 6 seconds), LED L1 will flash for 2 times regularly and it means that ROLLING CODE HCS remote controls can be memorized.

In case you need to go back to the “fixed code remote control “memorization” follow the passages 1 and 2, and wait that the **LED L1** will turn off. Once you memorized the first code, the receiver will manage remote control of the same Codes type. If the first remote control is a 12 bit (ex. Dip.switch), the receiver will memorize onlt 12 bit remote controls of the same type.

LED L1 in NORMAL status, indicated the type of codes

1 REGULAR FLASH memorization if only fixed code remote controls

2 REGULAR FLASHES memorization of **ROLLING CODE** remote controls like SMILE, SMART etc”

3.2 Remote control: code memorisation

The control unit has a **BUTTON P1** to program the working time and the memorization of the codes.

If you memorize a SMILE-C, make sure that all buttons have a code otherwise you can create a code. In case you want to memorize a rolling code remote control (for ex.SMILE-H) you don't need to create a code. The output of the control units should be deactivated, no contacts available and the lights should be turned off.

The outputs should be deactivated, no contacts available, the lights should be turned off.

This operation can be done only when the gates is closed

Memorise the first channel of the remote control for the command **OPEN (START)**

1	Press and release BUTTON P1 in the control board, LED L1 will lit on for 6 seconds. Then
2	Press (with 6 seconds) one button of the remote control which should be associated to the command OPEN (START). Led L1 will flash for 5 times to confirm the operation and then it flashes and it will flash normally as at the beginning. REMOTE CONTROL memorized.

Memorise the second channel of the remote control for the commande **CLOSE**

The logic is **CLOSE-STOP-CLOSE...** and it cannot be changed

1	Press and release button P1 in the control board, LED L1 will lit on for 6 seconds, Then
2	Press and release (in 6 seconds) button P1 in the control unit, LED L1 will lit on for 6 seconds. Then
3	Then in 6 seconds press the button of the remote control which should be associated to the command CLOSE (we suggest the 2nd channel). The logic is CLOSE-STOP-CLOSE... and it cannot be changed LED L1 will flash for 5 times to confirm the operation and then it flashes and it will flash normally as at the beginning. REMOTE CONTROL memorized.

Press (with 6 seconds) one button of the remote control which should be associated to the command OPEN (START). If LED L1 will flash immediately (without 5 flashes) it means that the memory is full and it cannot accept more remote controls. The memory capacity is 22 remote controls of 20bit, if you need more you have to install an external receiver (for example RX2 or RX4 with a memory capacity up to 3000 different codes).

If you are not sure of the memorization, start from point no.1 but before you have to cancel the memory.

4 Programming

4.1 Working time program

The control unit has a standard working time of **60 seconds and 20 seconds of pause**. This operation should be done in case you want to program different type of working time.





To program the different working time make the 6 steps as follow:

1	Give tension to the control unit and wait until LED L1 starts flashing
2	Give an OPEN or STEP-by-STEP command with the remote control or with the button
3	Press immediately BUTTON P1 in the control unit, LED L1 make flash shortly.
4	Press BUTTON P1 in the control unit when the gate is at the end
5	Wait the PAUSE TIME and press P1 in the control unit and press BUTTON P1 in the control unit.
6	Wait until the gate is closed. End of the operation.

! In point no.4 we suggest you to wait for a while before pressing the button after the opening limit switch is working. This is to avoid a partial opening in case the gates needs more time to get opened.

4.2 Cancelation of the Working time

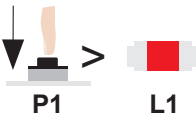
START S1XL can go back to the standard values, to cancel the program make as follow:

1		Turn off the control unit
2		Connect the control unit START-S1XL after a while
3		After 5 seconds from the turning on, press the button P1 until the LED L1 starts flashing
4		This program cancel all previous working time programs.



WARNING

This program cancel all previous working time programs.

4.3 Fixed light or flashing

Keep pressed the button **P1** for a fixed or a flashing light until the LED-L1 starts flashing when the gate is closing.

5 Connection of the BUS DATA SYSTEM

The control unit has a bi-directional BUS DATA with EB Protocol.

There is a MASTER of the same category available or from a keyboard. It is sufficient to give an activation or deactivation command for light to insert the control unit in a BUS DATA SYSTEM, the the control unit will be managed from a MASTER or a CONTROL device. We suggest to read the manual of the MASTER or from the control device.

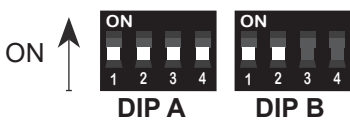
	<p>This is a free program for a specific address in the control unit. It is possible to install no.63 START-S1XL in the same BUS-DATA line. It is not possible to install in the same installation control units with the same ID.</p>
--	--

5.1 Example of the installation of BUSL2-XL

This is an example of an installation of 3 rolling shutters, connected with a Bus System, controlled from buttons in the input 5 of the BUS L2. This can consequently the opening and the closing of all rolling shutter through a single button. **The module is supplied to be installed in a 503E box.**

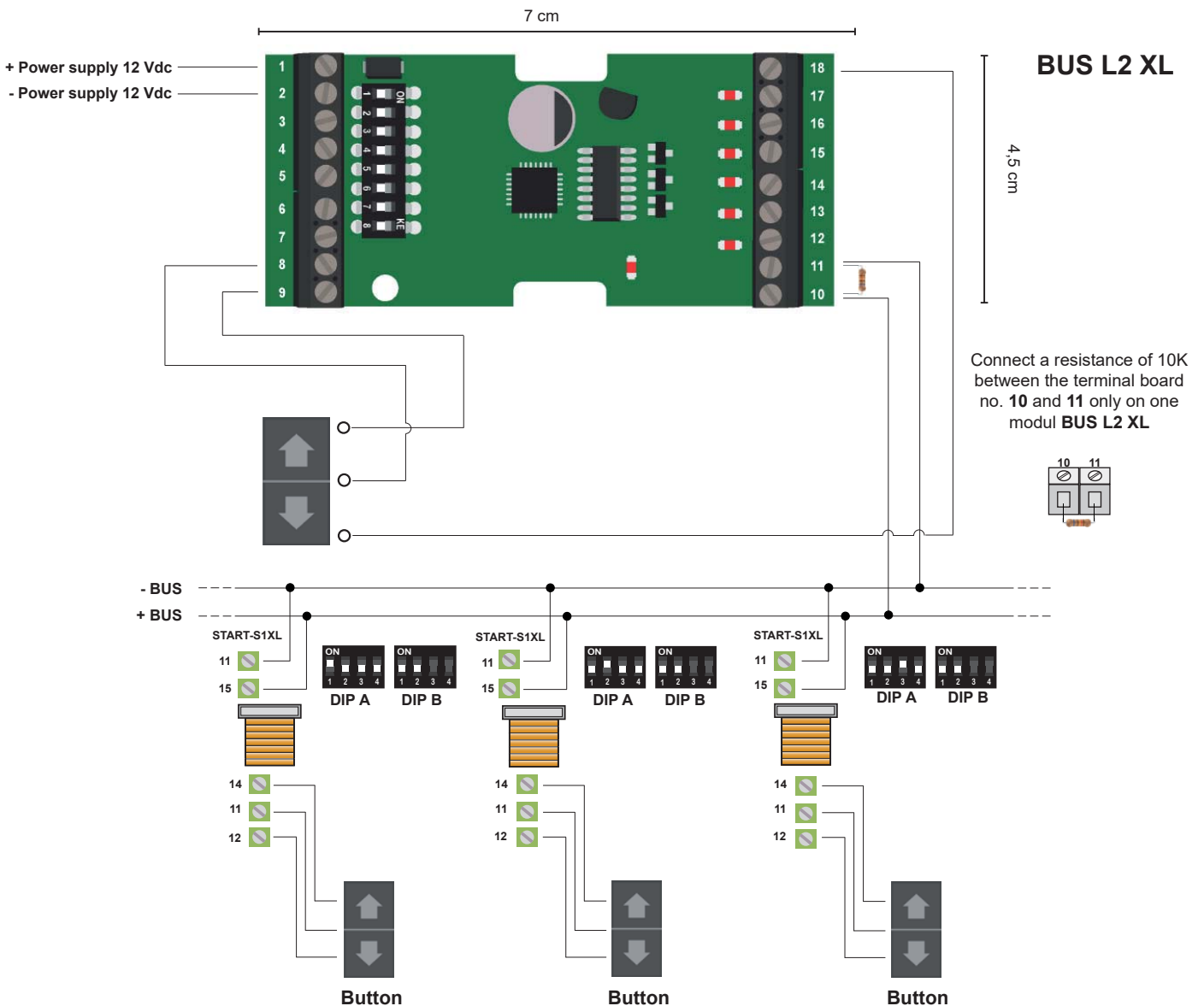

6 Declaration of CE conformity

(according to EC Directive 2006/42, Attachment II, part 1, ses. A)

The undersigned **Ernestino Bandera**,
Administrator

DECLARES THAT:



Company: EB TECHNOLOGY SRL
Address: Corso Sempione 172/5
21052 Busto Arsizio VA Italy
Product's name: START-S1XL
Universal control unit
for 1 sliding gate 230 Vac

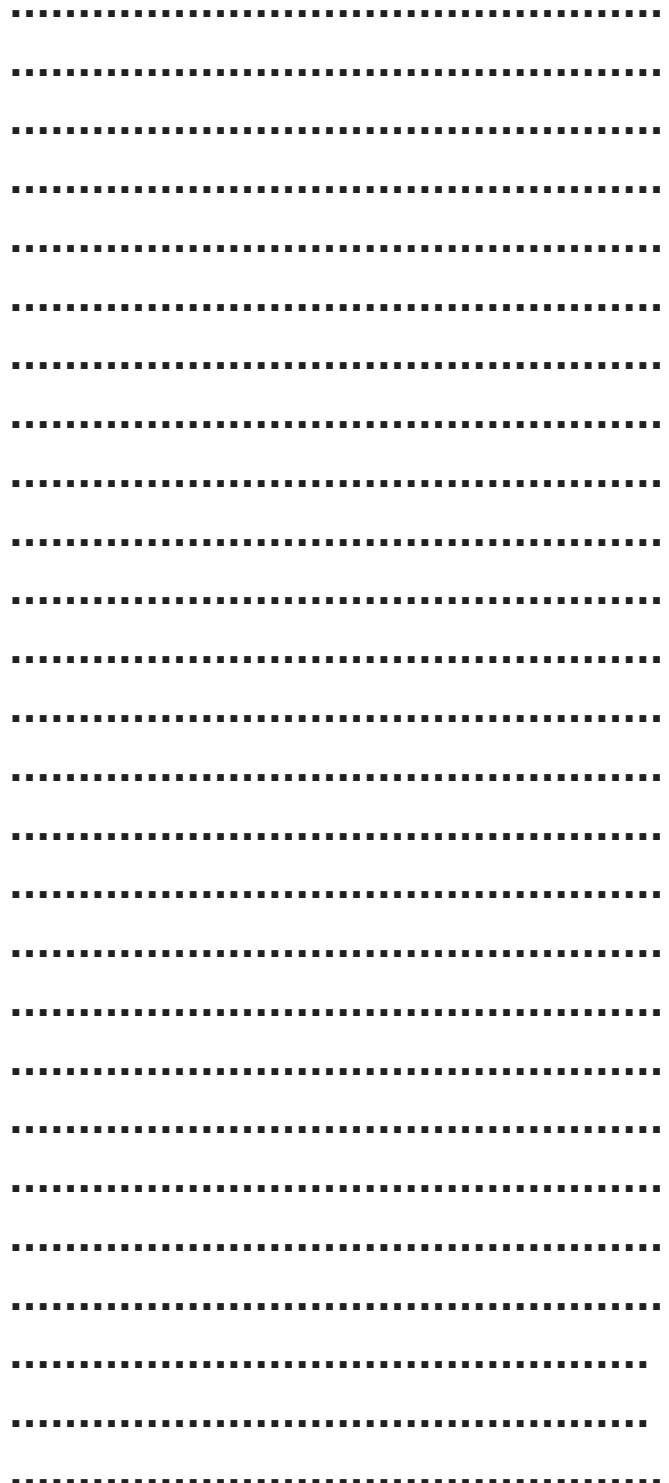

THE PRODUCT COMPLIES with what is outlined in the European Community directive:
2006/42/CE
EC DIRECTIVE 2006/42 ISSUED BY THE EUROPEAN PARLIAMENT AND COUNCIL on may 17, 2006 harmonizing the legislation of the member countries regarding machinery.
Reference: Attachment II, part 1, ses. A (EC Declaration of Conformity issued by the manufacturer).
THE PRODUCT COMPLIES with what is outlined in the European Community directives:
2014/35/EU
DIRECTIVE 2014/35/EU OF THE EUROPEAN PARLIAMENT AND OF THE COUNCIL of 26 February 2014 on the harmonisation of the laws of the Member States relating to the making available on the market of electrical equipment designed for use within certain voltage limits.
Reference to harmonized standards: EN 60335-1
2014/30/EU
DIRECTIVE 2014/30/EU OF THE EUROPEAN PARLIAMENT AND OF THE COUNCIL of 26 February 2014 on the harmonisation of the laws of the Member States relating to electromagnetic compatibility.
Reference to harmonized standards: EN 61000-6-2 EN 61000-6-3
THE PRODUCT COMPLIES with the essential requirements of article 3 of the following European Community Directive, for the use for which the product is designed:
2014/53/CE
DIRECTIVE 2014/53/EU OF THE EUROPEAN PARLIAMENT AND OF THE COUNCIL of 16 April 2014 on the harmonisation of the laws of the Member States relating to the making available on the market of radio equipment
Reference to harmonized standards: ETSI EN 300 220-3 ETSI EN 301 489-1 ETSI EN 301 489-3
The directive 2006/42/CE remind that it is not allowed the function of the product until the machine, for which the product is included, is not identify and declared conformed to the 2006/42/CE directive.

Busto Arsizio, 05/04/2017
The administrator
Ernestino Bandera

EB TECHNOLOGY S.r.l.
Corso Sempione 172/5,
21052 Busto Arsizio VA Italy

NOLOGO S.r.l.
via A. Pacinotti, 44
20020 Villa Cortese MI Italy
tel. +39 0331.430457
fax. +39 0331.432496



posta@ebtechnology.it
www.ebtechnology.it

info@nologo.info
www.nologo.info